

TR-10 Operator's Guide



Copyright © 2000
The Prometheus Group
One Washington Street, Suite 303
Dover, New Hampshire 03820

FOR ASSISTANCE, CALL YOUR LOCAL SALES REPRESENTATIVE, DISTRIBUTOR, OR *THE PROMETHEUS GROUP* AT 800.442.2325 IN THE U.S. AND CANADA OR 603.749.0733 INTERNATIONAL. FOR TELEPHONE TECHNICAL SUPPORT CALL 800.272.8492 IN THE U.S. AND CANADA OR 603.742.6053 INTERNATIONAL.
WEBSITE: www.theprogrp.com E-MAIL: info@theprogrp.com

CONTENTS

NOMENCLATURE	3
SERVICE INFORMATION	3
TECHNICAL SUPPORT	3
INDICATIONS FOR USE	4
CONTRAINDICATIONS	4
Cautions	4
Warnings	5
CHAPTER 1: PHYSICAL-MECHANICAL OVERVIEW	6
Physical	6
<i>The Front Panel</i>	6
<i>The Rear Panel</i>	6
<i>The Top panel</i>	7
Mechanical	7
<i>Connecting the Pathway™ Preamplifier Cables</i>	7
<i>Pathway Adapter</i>	8
<i>Intracavity Vaginal/Rectal EMG/Stimulation Sensors</i>	9
<i>24" Electrode Lead Wire Set</i>	10
CABLE CONNECTION FOR PRACTICE SESSION	11
CABLE CONNECTIONS	11
DISPLAY	13
<i>Front Panel LED Indicators</i>	13
<i>Status Indicators</i>	13
<i>Bar Graph Display</i>	13
CHAPTER 2:	14
OPERATION	14
Start-up Display	14
<i>1st Screen Battery Level Indication During Start-up</i>	14
<i>2nd Screen Feedback Mode and Display Range indication during start-up</i>	15
<i>3rd Screen Measurement Mode indication during start-up</i>	15
Training Session	16
Displaying EMG	16
Expanded EMG Display Range	17
Expanded Display Range Scale	18
Setting the Display Range	19
Feedback and Timing Modes	19
Setting the Feedback Mode	20
Goal Display	20
Setting the Goal Value	21
Work/Rest Intervals	22
Pathway TR-10	23
Technical Specifications	23
STANDARD WARRANTY SERVICE AGREEMENT	24

2011 The Prometheus Group. All rights reserved. This document contains confidential and proprietary information that is the property of The Prometheus Group, Inc. and is protected by the copyright laws of the United States, international copyright treaties, and all other applicable national laws. Any unauthorized use, reproduction or transfer of any information in this document is strictly prohibited. This document contains information regarding technology that is protected under one or more United States patents and other pending United States and foreign patents. The Prometheus Group logo and combinations thereof, Prometheus, Pathway, and DUO are trademarks of The Prometheus Group, Inc., One Washington Street-Suite 303, Dover, NH 03820. All other brand and product names are used for identification only and are the property of their respective holders. Specifications are subject to change without notice. Printed in U.S.A.

NOMENCLATURE

In this Operator's Guide, **NOTES**, **CAUTIONS**, and **WARNINGS** are included, which have the following implications:

NOTE: A procedural emphasis - usually something regarding preparation for a process or a reminder that some bit of information recorded here will be used later for another purpose



CAUTION: A hazard to a piece of equipment or property - for example, potential for an electrical short, water damage, or some other danger to the equipment but not the operator or patient. Can also be a reference to HIPAA or other medical legal requirement.



WARNING: A hazard to a person - a potential danger to the operator or patient such as electrical shock or some other potential danger.

SERVICE INFORMATION



WARNING: There are no serviceable parts within this device. The user should not attempt to service the instrument beyond that described in the TR-10 Operator's Guide. Refer all other servicing to qualified service personnel. Please call 1-800-272-8492 in the U.S.A. and Canada, or +1 (011) 603-742-6053 international, or e-mail support@theprogrp.com



The instrument should be serviced by qualified service personnel when:

- Any cable, cord, or plug has been damaged.
- The instrument does not appear to operate normally or exhibits a marked change in performance.
- The instrument has been dropped, or the casing is damaged.
- Fluid has been spilled on the instrument, or it has been immersed, and it appears that fluid has entered the housing.

TECHNICAL SUPPORT



To contact The Prometheus Group Technical Support for assistance: Telephone: 800-272-8492 U.S.A. and Canada; +1 (011) 603-742-6053 international; e-mail: support@theprogrp.com. Technical Support Representatives are available to assist you between 9:00 a.m. and 5:00 p.m., Eastern Time.

INDICATIONS FOR USE

Surface electromyography is a safe and effective technique for **relaxation training** and **muscle re-education**.

Using internal sensors such as the Pathway Vaginal EMG Sensor:

EMG biofeedback is a safe and effective technique for the assessment and treatment of pelvic floor dysfunction, monitoring the performance of Kegel exercises. The pelvic floor muscles include the Levator Ani group as well as the pubococcygeus (PC), ileococcygeus, and coccygeus. These are skeletal muscles which respond to re-education, strengthening, endurance building, and relaxation.

Conditions that can be assessed or treated using this technique include: **stress incontinence**, **mixed incontinence**, and **urge incontinence**.

CONTRAINDICATIONS

Do not use this device for treatment of incontinence in the presence of any **bladder infection**, **vaginal infection**, or **during pregnancy**.

Cautions



Prior to using this device, be sure to read the Pathway Device Operator's Guide for installation, maintenance, cleaning, technical data, service, and warranty information.



Federal law (USA) restricts this device for sale by or on the order of a licensed medical practitioner, licensed by law in the state in which they practice.













Federal law (USA) restricts this device for sale by or on the order of a physician when used for the treatment of incontinence.



Use only electrodes from The Prometheus Group with your Pathway surface EMG device. Any other electrode may not be compatible with the Pathway device.

Warnings

-  This device is not intended for use with anesthetic gases mixed with air, oxygen or nitrous oxide. Danger of electrical ignition.
-  Be sure to read this operator's manual before using this device.
-  Use only electrodes from The Prometheus Group with your Pathway device. Any other electrodes may not be compatible with the Pathway device.
-  Do NOT immerse any part of this device in any fluid.
-  To reduce the risk of electrical shock, do NOT connect any preamplifier, lead wire, electrode, or any other component to a wall outlet.
-  Do NOT leave electrodes attached when device is not in use.
-  To reduce the risk of electrical shock, do NOT open the instrument's housing. Refer servicing to qualified personnel only.
-  Disassembly of equipment by unauthorized personnel will void the instrument's warranty.
-  The following practices may be dangerous and void any guarantee(s) and obligations for The Prometheus Group: (1) The device is not used according to the enclosed manuals and other accompanying documentation; (2) The device is modified by persons other than The Prometheus Group Service Technicians; (3) Do not use accessories, consumables and components not supplied or approved by The Prometheus Group.
-  Use only batteries with this device, do not use any type of line-powered adapter.
-  For the treatment of incontinence do not attempt to use this device concurrently with stimulation being supplied from an electrical muscle stimulator.

Equipment & Accessories

Before using the TR-10 for the first time, carefully open the packing carton and confirm that all equipment and accessories listed below are included and agree with the packing List/Invoice. If there are questions about the contents or you wish to order additional supplies, call Customer Service, Toll-Free: **1-800-442-2325** in the U.S.A. and Canada, **+1 (011) 603-749-0733** international, or Fax: **1-603-749-0511**. Customer Service Representatives are on duty between 9:00 a.m. and 5:00 p.m., Eastern Time.

Contents

The Pathway TR-10 kit contains the following items:

- The Pathway TR-10 module
- One preamplifier cable for EMG input
- One 9 volt alkaline battery
- One sample package of 6750 electrodes
- One carrying case
- Operator's Manual

CHAPTER 1:

PHYSICAL-MECHANICAL OVERVIEW

Physical

THE FRONT PANEL



The example pictured above is the **Pathway™ TR-10**. Note input channel. EMG input for the Pathway™ Preamplifier (part# 2583).

- One LED bar graph to display microvolt level, goal type and goal level
- Four individual LED indicators to provide status information
- Up and down arrow keys to change the goal
- An A key to define EMG A goal type and direction

THE REAR PANEL

9 volt battery compartment (the unit's serial number is located inside)

To install or change the battery simply press down on the designated area and slide the cover in the direction indicated. Connect the battery noting orientation of battery terminals, place the battery in the compartment, and replace the cover, snapping firmly into place. Either a disposable or rechargeable battery may be used. If using a disposable, an alkaline battery is recommended for longer life. A fresh alkaline battery will have 20-25 hours of useful life.

THE TOP PANEL

Power On/Off Rotary Switch:

The thumbwheel switch turns the power on and off and adjusts the volume to the Pathway™ Clinical unit. Power the TR-10 device on by rotating the switch clockwise, power off by the TR-10 device by rotating the switch counter clockwise. Powering the TR-10 device on will activate three information screens in succession. The first will show a red LED which will indicate the battery level, the second will show two red LEDs (the top LED indicating the scale while the lower LED indicates the mode) and then the final screen display becomes active.

Mechanical

CONNECTING THE PATHWAY™ PREAMPLIFIER CABLES

Note: The Pathway™ Preamplifier (part# 2583) cables are color coded with **white** and **gray** cable to distinguish which is **EMG A** or **EMG B** when being used with a dual channel unit. Either colored preamplifier cable can be used for the TR-10 unit.

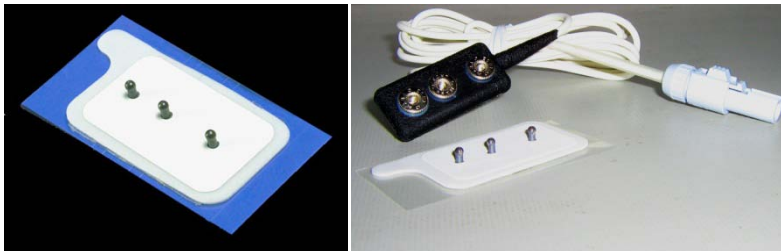

Pathway Electrode (left).

Pathway Electrode with white Pathway Preamplifier (right).

1. Primary and secondary muscles are monitored by placing the active electrodes over the bulk of the muscle. The Pathway™ Preamplifier (part# 2583) has three female snaps" two labeled **ACT** (active) and one labeled **GND** (ground). Prepare the skin with an alcohol pad to avoid high impedance artifact. Wipe dry with a tissue or cloth. Snap the Pathway™ Preamplifier (part# 2583) onto one of the Pathway™ Electrodes (part# 6750) taking care to orient the snaps correctly. Verify all three snaps are secure. Carefully remove the backing of the Pathway™ (part# 6750) Electrode and place the two labeled **ACT** (active) over the bulk of the muscle with the length of the electrode parallel with the muscle fibers. Make certain the Pathway™ Preamplifier (part# 2583) cable is fully seated into the EMG input channel.

2. Accessory Muscles such as Abdominals, Leg Adductors and Gluteals are commonly monitored by placing the active electrodes over the bulk of the muscle. In the example below the Pathway™ Electrode (part# 6750) has been placed on the patient's right side of the abdomen, just above the pubic hairline.



Positioning the Patient Electrodes on the accessory muscle.

PATHWAY ADAPTER



This adapter allows the EMG input to accept the intracavity sensors or external pelvic muscle electrode lead wire sets for incontinence applications. Open the Velcro sleeve, match the female snaps on the end of the Pathway™ Preamplifier (part# 2583) cable with the male snaps of the Pathway™ Adapter (part# 3660), connect and re-wrap the Velcro sleeve. Note the six pin mini din connector input at the end of the Pathway™ Adapter (part# 3660).

INTRACAVITY VAGINAL/RECTAL EMG/STIMULATION SENSORS

Pathway 6330 Vaginal Sensor

Pathway 6340 Rectal Sensor

Internal: Connect either the Pathway 6330 Vaginal EMG/Stimulation Sensor or the Pathway 6340 EMG/Rectal Stimulation Sensor (see Figure above) into the Pathway™ Adapter (see previous Figure). Make certain orientation of connector matches input jack, push firmly (**do not twist**). Refer to the instructions for use enclosed with each sealed sensor bag.



Note: Do not use accessories, consumables and components not supplied or approved by The Prometheus Group. Using these items may result in inaccurate readings, miss-diagnosis, or possible damage to your unit and void your unit's warranty.

24" ELECTRODE LEAD WIRE SET



24" Electrode Lead Wire Set (part# 5328)



Easytrode™ Pregelled electrodes (part# 6801)

Snap the two red and one green lead wires onto the Easytrode™ Pregelled electrodes (part# 6801). Remove the Easytrode™ Pregelled electrodes (part# 6801) individually.

As shown in the example below place the two red (active) lead wires at the 4 and 10 o'clock positions around the anus. Place the green (reference/ground) lead wire over the ischial tuberosity or buttocks muscle. Make certain orientation of 24" electrode lead wire connector matches Pathway™ Adapter input jack, push firmly (**do not twist**).

Surface Peri-Anal Placement

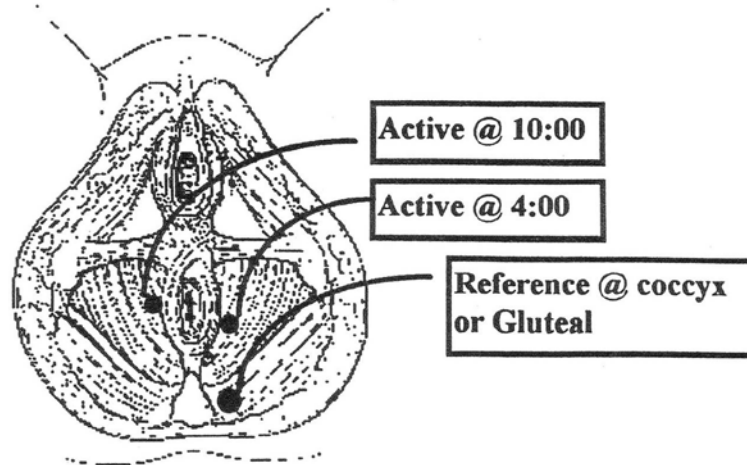

Positioning the Patient Electrodes on the primary muscle.

CABLE CONNECTION FOR PRACTICE SESSION

- Connect white preamp (Patient Cable) to EMG input.
- Snap Pathway Electrode onto the black molded end (with three snaps).
- Place the Electrode on your flexor muscle of forearm.

(parallel with the muscle fibers; long edge of electrode will be same direction as arm).
Place on the "Belly" of the muscle.

Also see Cable Connection illustrations.

- **Rest your target muscle (arm).**

The LED display should read 5 or under. (2 or 3 is not uncommon)

- **Contract your muscle.**

The reading on the bargraph should increase.

The continuous mode could be used to check a patients' **Resting Baseline** by instructing the patient to relax and reading the bargraph.

CABLE CONNECTIONS

Use illustrations to **connect cables, electrodes** and **accessories**.

Choose from the following configurations:

1. **Orthopedic** (see example below)
2. **Continance: Internal Sensor** (see example on the following page)
3. **Continance: External Pelvic Floor Monitoring** (see example on the following page)

NOTE: Illustrations can also be helpful for **part identification** and **re-order numbers**. Images shown are of a TR-10C for demonstration purposes.

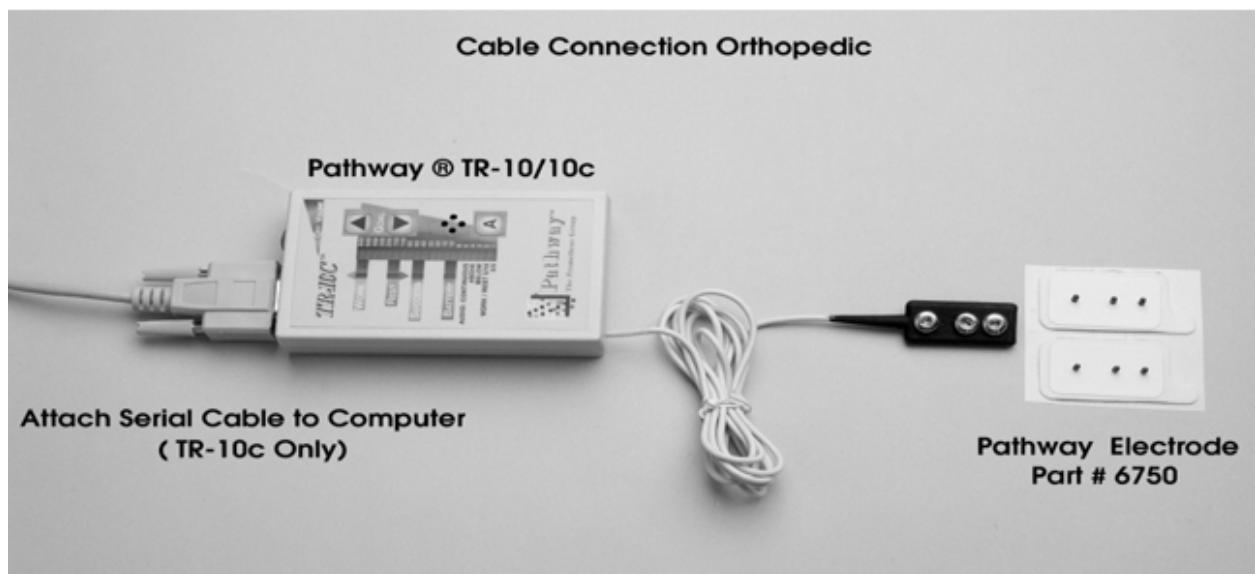

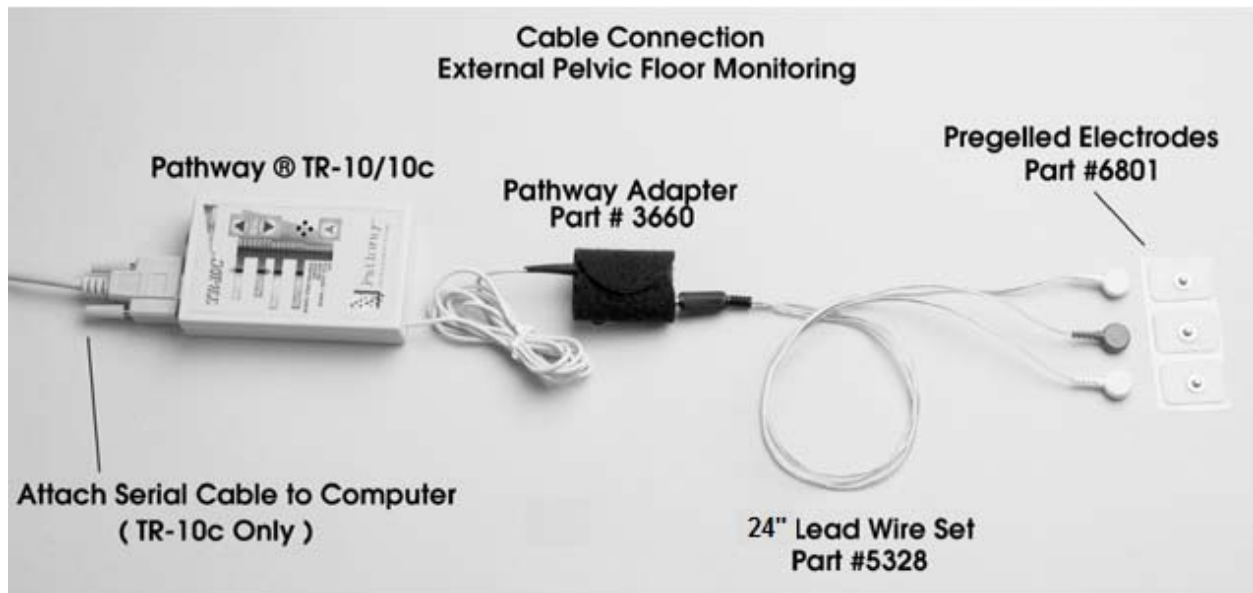
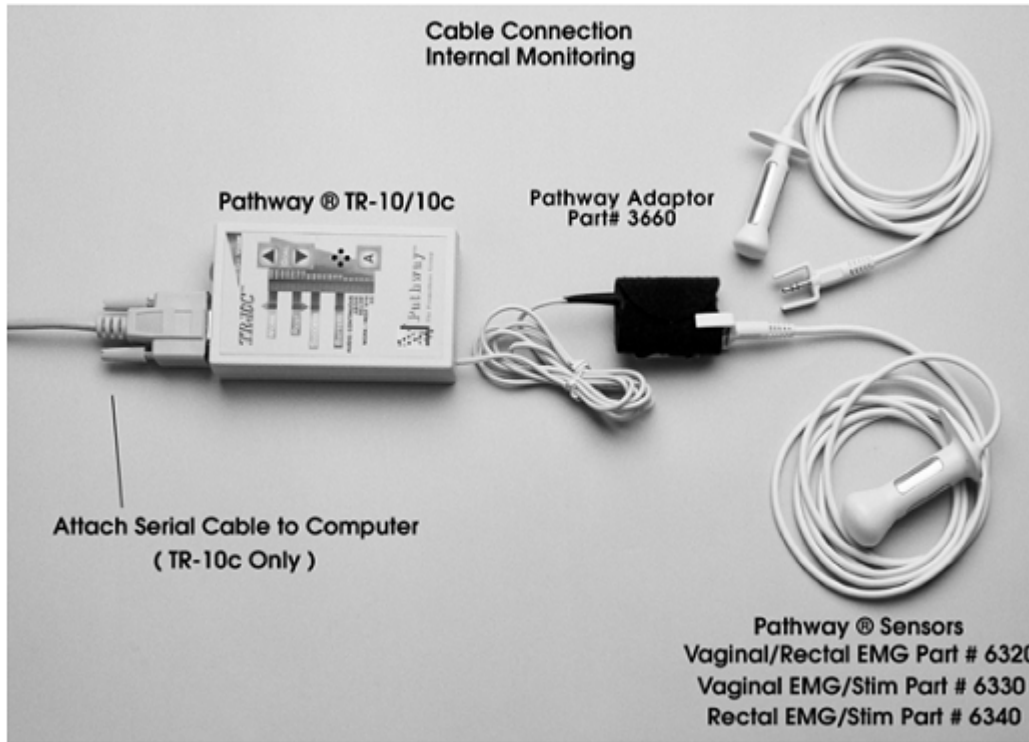

DISPLAY

FRONT PANEL LED INDICATORS

The TR-10 uses LED indicators to display information. These LEDs are labeled with their meaning or values. Some indicators are used for more than one function such as displaying EMG level and goal level or goal type. The TR-10 uses 4 individual LED indicators and one Bar Graph Display.

STATUS INDICATORS

The TR-10 has 4 LED indicators labeled **BATTERY**, **WORK**, **REST**, and GOAL **SUCCESS**. These are used to show information about the current state.

The **BATTERY** indicator lights during start-up while showing battery level on the bar and begins blinking during operation if the battery voltage drops too low.

The **WORK** and **REST** indicators light when the unit is in the **Work/Rest timing mode**. The **WORK** LED will light when in a **Work period** and the **REST** LED will light when in a **Rest period**.

The GOAL **SUCCESS** indicator lights when goal success is achieved.

BAR GRAPH DISPLAY

The bar graph display is used to show the current levels of EMG by lit LED's based on the scale from 1 to 800 microvolts in the normal display range or on the scale of 1 to 30 microvolts in the expanded display range. When a goal is set the goal level is also shown on the bar graph by one lit LED.

The bar graph display is also used to show the current settings for the TR-10 during start-up and when making selections. The bottom of the display will indicate the goal type and the 800 light or the 30 light will indicate the current display range

CHAPTER 2:

OPERATION

Start-up Display

- **Turn the unit ON** by turning the **Thumbwheel** switch clockwise. The thumbwheel switch also adjusts the volume.
- When first turned on, the TR-10 will sound a several second tone which may be used to adjust the speaker volume to a comfortable level.
- The TR-10 unit will progress through **3 screens** utilizing the display LED's to indicate **Battery Level, Current Feedback Mode** and the **Measurement Mode**. The progression of the screen changes is approximately 3 seconds between each sequential change.

1ST SCREEN BATTERY LEVEL INDICATION DURING START-UP

During the start-up tone, the current battery voltage is indicated on the Bar Graph display while the **BATTERY** LED indicator is lit. The top of the display indicates a new battery. As the battery voltage drops during its lifetime the level indicated on the display will drop as well. The bottom of the display indicates that the battery is at the end of useful life and should be replaced. In the example below the battery currently being used is approximately in its mid-life cycle.

Battery indication on start-up:



NOTE: The Unit only gives you approx. 3 seconds to view information between screens. If the TR-10 is turned on and does not work properly, first try replacing the battery (unit uses a 9V battery). Call Technical Support for further assistance if necessary.

2ND SCREEN FEEDBACK MODE AND DISPLAY RANGE INDICATION DURING START-UP

After showing the battery level, the **Bar Graph Display** on the TR-10 will now show the **Current Feedback Mode** and display the **Range/Scale** setting. The bottom LED indicates the **Current Feedback Mode** while the top LED indicates the **Range/Scale** setting. In the example below the current goal type is **AUDIO: CONTINUOUS** and the current range/scale is **800**.



NOTE: When first powered on the TR-10 Unit defaults to **AUDIO: CONTINUOUS** for the **Feedback Mode** and **800** for the **Range/Scale**.

3RD SCREEN MEASUREMENT MODE INDICATION DURING START-UP

After displaying the Current Feedback Mode and the Range/Scale setting, the **Bar Graph Display** on the TR-10 will now be in "**Measurement Mode**". The start-up sequence has been completed and the Pathway TR-10 will automatically display EMG activity. The current level of EMG activity is shown by the illuminated LEDs on the bar graph. The values of the illuminated LEDs are shown on the scale immediately to the right of the **Bar Graph Display**.



Training Session

A few seconds after being turned on, the Pathway TR-10 will automatically display EMG activity. The current level of EMG activity is shown by the illuminated LEDs on the bar graph. The values of the illuminated LEDs are shown on the scale immediately to the right of the bar graph display.

Although only 20 LEDs are used the TR-10 uses 2 levels of brightness and lights pairs of LEDs to show 4 times as many levels. For example the following sequence is used between 2 LEDs:

	STEP 1	STEP 2	STEP 3	STEP 4	STEP 5
LED 2:	OFF	HALF ON	FULL ON	FULL ON	FULL ON
LED 1:	FULL ON	FULL ON	FULL ON	HALF ON	OFF

The next step after step 4 is the same as step 1 but is increased by 1 to the next LED position up on the display. Note that this sequence is an analog representation which gives an excellent feeling of the values in between the LEDs. When this display is combined with the normal EMG value changes, it shows the EMG levels just as if there were 80 LEDs in each bar!

During a training session the display bar shows the EMG level of the A channel. Note that **increasing muscle activity moves the LEDs up** and **decreasing activity moves the LEDs down**.

Displaying EMG

To observe the operation of the display, connect the EMG preamplifiers to the TR-10 and apply the electrodes to a convenient area such as the forearm, as described in the section "**Connecting the Preamplifier Cables**". Note how the moving LEDs on the bar display ascends and descends, as the hand and wrist muscles are contracted and relaxed.

Because EMG is essentially a logarithmic function, this type of scaling is used for the moving LEDs on the bar display. As a result, the movement of the LEDs relates directly to the change in muscle activity.

The changing digital numbers represent **microvolt (uV)** levels of EMG activity and **increase when contracting** and **decrease when relaxing**.

The total microvolt scale is **1 to 800 uV RMS**.

Expanded EMG Display Range

The TR-10 has an expanded display range where the Bar Graph Display is used to show from 1 to 30 microvolts instead of the normal 1 to 800. This is graphically illustrated:

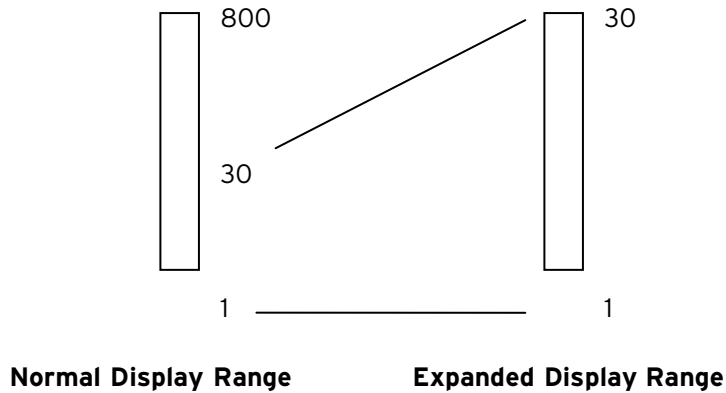

The expanded display range is useful when EMG activity remains at very low levels. When only the bottom few LED's are being illuminated in the normal display range, using the expanded display range will use more of the Bar Graph Display and provide improved visual feedback to the patient.

The top of the Bar Graph Display represents 30 microvolts when using the expanded display range. The Bar Graph Display uses same type of logarithmic scaling used in the normal range. This scaling can be seen in the section **Expanded Display Range Scale** on the next page. If the EMG activity exceeds 30 microvolts and goes off the scale, the top LED will remain illuminated to show full scale has been achieved.

Expanded Display Range Scale

The labeled microvolt values on the scale immediately to the right of the Bar Graph Display are for the **normal display range**. These labeled values **no longer apply when in the expanded display range (30 Range)**. The actual microvolt values for the expanded display range (30 Range, shown to the left of the display bar in the example below) correspond to the listed value of the 800 Range (Normal Range). An example would be 30 from the 30 range (expanded display range) would be equivalent to 800 from the 800 Range (Normal Range).

30 Range		800 Range
30		800
25		600
20		400
18		300
15		200
13		150
11		100
9		80
8		60
6.5		40
5.5		30
4.5		20
4		15
3.5		10
3		8
2.5		6
2		4
1.7		3
1.5		2
1		1

NOTE: If using the Expanded Display Range (30 Range) on a consistent basis, a piece of scotch tape with the corresponding 30 Range values written on it may be used to cover the Normal Range (800 Range) values versus verifying corresponding values from the above chart.

Setting the Display Range

Press the A key once to check the current settings on the TR-10. The EMG activity will temporarily be suspended while the display shows the current display range (either **800** or **30 range**) and the current feedback mode. The current range is indicated by a flashing LED next to the **800** or next to the **30**. Use the **up arrow key** to select the **800** microvolt display range and the **down arrow key** to select the **30** microvolt display range. Both the **800 scale (normal range)** and the **30 scale (expanded display range)** can be seen in the example below.



800 Scale
(Normal Range)



30 Scale
(Expanded Display Range)

When the desired display range is indicated on the Bar Graph, do not press any keys and the display will return to EMG activity with the selected range.

Feedback and Timing Modes

Feedback mode choices are: ■

- 1) **AUDIO: CONTINUOUS** -- Audio feedback (pulsed tone proportional to EMG Level); continuous session.
- 2) **ABOVE** -- Audio feedback when contracting above goal; continuous session.
- 3) **BELOW** -- Audio feedback when relaxing below goal; continuous session.
- 4) **WORK / REST 5/10** -- Work/Rest, sets of 5 seconds work and 10 seconds rest; above tone goal.
- 5) **10/10** -- Work/Rest, sets of 10 seconds work and 10 seconds rest; above tone goal.

Setting the Feedback Mode

The **A key** is used to set the feedback mode for EMG. By pressing the **A key** once, the current mode will be momentarily displayed on the bar graph. In this case the display will indicate that no goal is set by flashing the **AUDIO: CONTINUOUS** LED.

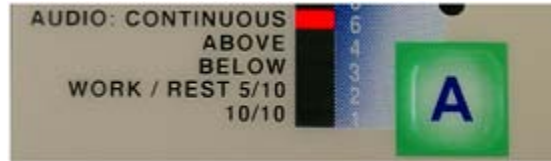

To change the mode simply press the **A key** again until the LED next to the desired mode is flashing. When no keys are pressed for a few seconds, the TR-10 will return to the real-time EMG display with the selected goal type and timing mode enabled.

NOTE: When the TR-10 unit is first powered on, the unit defaults to the **AUDIO: CONTINUOUS** mode.

Goal Display

When one of the goals is enabled, one LED on the bar will be illuminated. The position of this goal LED in the display represents an absolute microvolt goal at the corresponding labeled value for the normal display range. If the goal is the LED labeled 20, the goal is set at 20 microvolts for the normal display range.

In the expanded display range (30 scale), the goal level is indicated relative to the expanded display scale. To set an absolute microvolt goal, use the normal display range to set the goal level to the desired labeled value and then return to the expanded display (30 scale) range.

Goals are active only in a continuous session or a work period. If a goal is set at 20 microvolts and the EMG level is higher than the goal the display should look something like:

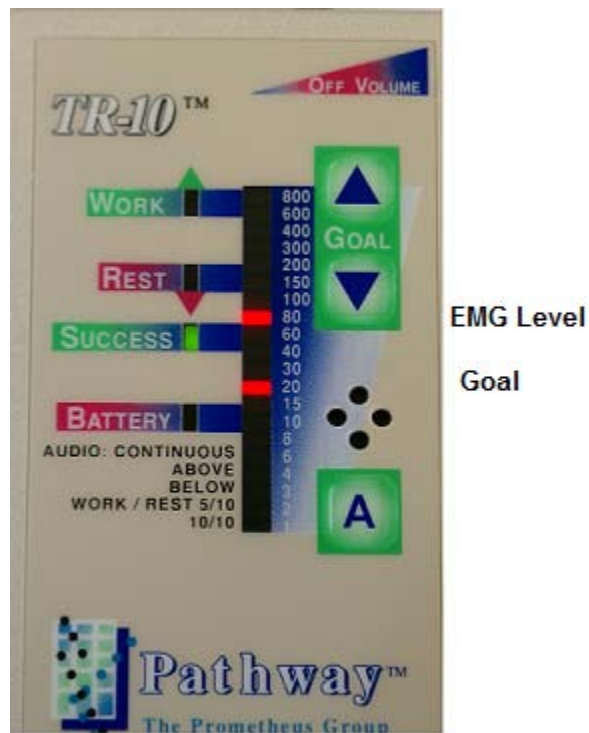

If an **ABOVE** goal is selected and the EMG activity meets or exceeds the goal, a pulsed tone will be heard. This pulsed tone will have a rate which is proportional to the current level of EMG. The **GOAL SUCCESS** LED will also be lit (unless in a rest period).

Setting the Goal Value

When a tone goal type is initially selected, the **default goal value is 10 microvolts**. To change the goal value, the **UP** and **Down Arrow Keys** are used.

NOTE: The display bar still shows the current level of EMG activity, so that goals can be changed without interrupting the training session.

The **Goal value** is always displayed relative to the current microvolt display range.

To change the **Goal value**, simply press the appropriate arrow key until the desired goal is reached. Use **single key presses to increment or decrement** the **Goal value**, or **hold the key down for larger changes**. The position of the goal LED will change to reflect the current value.

While changing the goal value the goal LED will blink on the bar graph display. When the desired goal value is displayed, do not press any keys and the TR-10 will return to normal operation.

The scale labeled to the right is for the normal 800 microvolt display range only. To set an absolute microvolt goal, use the 800 microvolt display range to set the goal level and then set the 30 microvolt display range.

Work/Rest Intervals

The TR-10 may be put in the **Work/Rest** timing mode if a series of short contractions rather than one long session is desired by the clinician. In this mode the TR-10 cycles between work periods and rest periods. When the TR-10 is in a work period the **WORK** indicator will light and when the TR-10 is in a rest period the **REST** indicator will light.

There are two **Work/Rest** timing modes to choose from: **5/10** or **10/10**. The **5/10** work/rest mode yields a **work time of 5 seconds** and a **rest time of 10 seconds**, and the **10/10** work/rest mode yields a **work time of 10 seconds** and a **rest time of 10 seconds**.

NOTE: In the work/rest timing modes the goal is always an **ABOVE** tone type of goal. This goal is **only active during the work periods**, although it is still shown during the rest periods. The **success tone** and **GOAL SUCCESS** indicator **only become active during work periods**.

Pathway TR-10

Technical Specifications

- One EMG Channel
- Active Electrode Preamplifier
- Microvolt Range
- One Logarithmic Display Range
- Above/Below Tone Goals
- True RMS Conversion
- to 500 Hz Bandpass
- No Notch Filter
- Input Common Mode Rejection greater than 110dB
- Input Noise Level of <1 Microvolt
- Active Electrode Impedance of 10 gigohms
- Accuracy of 2 Microvolts +/- 2%
- Dimensions: 4.6" x 2.7" x 1.0"
- Power: Standard 9 Volt Battery

Electromagnetic Compatibility and Interference

The Pathway TR-10 has been tested for Electromagnetic Compatibility and Electromagnetic Interference and complies with the requirements set forth in EN 60601-1-2:1993, to include EN55011:1991 for radiated emissions, IEC 801-2:1991, and IEC 801-3:1991 (Draft).

Electrodes

To re-order electrodes for any Pathway device please call your dealer or The Prometheus Group sales office at (800)-442-2325.

For surface EMG applications the compatible electrodes order numbers are (from The Prometheus Group) **6750 (Pathway Electrodes - bag of 100)** for the Pathway preamplifiers and **6801 (Easytrode Electrodes - bag of 150)** for individual lead wires (24" Electrode lead wires).

For incontinence applications the compatible electrodes (internal sensors) are the **6320 (Pathway Vaginal/Rectal EMG Sensor)**, **6330 (Pathway Vaginal EMG/Stimulation Sensor)** and the **6340 (Pathway Rectal EMG/Stimulation Sensor)**.

STANDARD WARRANTY SERVICE AGREEMENT

The Prometheus Group warrants equipment of its own manufacture to be free from defects in material and workmanship as follows:

One (1) year from the date of shipment to the original purchaser, subject to the terms, conditions, limitations, and exclusions specified herein.

1. **Service:** The Prometheus Group of New Hampshire, Ltd., hereafter "The Prometheus Group", shall provide, for the term of this warranty, repair of defective Prometheus Group units. This warranty shall include all parts and labor charges. The purchaser must obtain a Return Authorization Number and must return the defective unit, at the purchaser's own expense to The Prometheus Group. The Prometheus Group may, at its option, repair and return the unit or provide a replacement unit. Should The Prometheus Group elect to provide a replacement unit, then this warranty is automatically transferred to the replacement unit. The Prometheus Group shall return, at The Prometheus Group's own expense, the repaired or replacement Prometheus Group unit.
2. **Exclusions:** The following conditions are excluded from service under this warranty:
 - A. Preventative maintenance. Preventative maintenance, defined as maintenance performed for the purpose of preventing a malfunction, is excluded from service under this warranty.
 - B. Repair of damage or malfunction of Prometheus Group equipment resulting from abuse, accident, modification, usage of accessories, consumables and components not supplied or approved by The Prometheus Group, or other cause other than normal usage, including but not limited to operator error, failure of other user-supplied equipment, and equipment operation in excess of design specifications is excluded from service under this warranty.
 - C. Loss due to fire, flood, robbery, burglary, theft, vandalism, radioactive contamination, or other natural disasters or Acts of God is excluded from service under this warranty
 - D. Replacement of batteries, accessories and expendables such as electrodes, are excluded from service under this warranty.
3. **Optional Warranty Extension:** This warranty may be renewed or extended by written agreement and acceptance of both parties. The price for such extension shall be the price in effect at the time the extension is put in force. The Prometheus Group shall waive any inspection and conditional repair requirements for uninterrupted warranty extensions.
4. **Limitation of Remedy:** The Prometheus Group shall not be liable for any damages caused by the delay in furnishing warranty services or other performance under this warranty. The service warranty expressed in paragraph 1 represents the sole and exclusive remedy for any warranty claims under expressed or implied warranties, including without limitation any warranty of merchantability or fitness. This warranty specifically limits the liability of The Prometheus Group, including liability for negligence claims by users and disclaiming any other claims of non-performance by The Prometheus Group. In no event shall The Prometheus Group be held liable for any incidental or consequential damages of any kind.
5. **Assignment:** This warranty shall not be assigned by the purchaser without prior written consent of The Prometheus Group. The warranty shall be binding upon all of the parties and their successors and assigns.